



ANGULAR CONTACT BALL BEARING



ANGULAR CONTACT BALL BEARING

ANGULAR CONTACT BALL BEARING

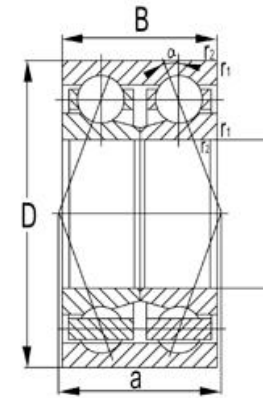

Bearing No.	Boundary dimensions				Basic load ratings(kN)		Limiting speed		Mass kg
	mm				Dynamic	Static	rpm		
	d	D	B	r _{smin}	Cr	Cor	Grease	Oil	
3200	10	30	14.3	0.6	8.4	6.5	14000	19000	0.051
3201	12	32	15.9	0.6	8.45	6.7	13000	17000	0.06
3202	15	35	15.9	0.6	11.1	9.05	11000	15000	0.069
3203	17	40	17.5	0.6	14.2	11.8	9900	13000	0.099
3204	20	47	20.6	1	17.5	15.2	8800	12000	0.166
3205	25	52	20.6	1	19.3	18.4	7300	9800	0.183
3206	30	62	23.8	1	27.7	27.4	6300	8400	0.303
3207	35	72	27	1.1	37.5	38	5500	7400	0.458
3208	40	80	30.2	1.1	40.5	45	4900	6600	0.627
3209	45	85	30.2	1.1	46.5	52	4400	5900	0.678
3210	50	90	30.2	1.5	52.5	60	4000	5300	0.698
3211	55	100	33.3	1.5	66	76.5	3600	4900	1.07
3212	60	110	36.5	1.5	70.5	88	3400	4500	1.34
3213	65	120	38.1	1.5	78	99	3100	4200	1.68
3214	70	125	39.7	1.5	86	110	2900	3900	1.84
3215	75	130	41.3	1.5	94	122	2700	3600	2
3216	80	140	44.4	2	104	131	2500	3400	2.71
3217	85	150	49.2	2	121	155	2400	3200	3.48
3218	90	160	52.4	2	135	170	2200	3000	4.24
3219	95	170	55.6	2.1	144	184	2100	2800	5.1

ANGULAR CONTACT BALL BEARING

3220	100	180	60.3	2.1	189	234	2000	2700	5.88
------	-----	-----	------	-----	-----	-----	------	------	------



ANGULAR CONTACT BALL BEARING

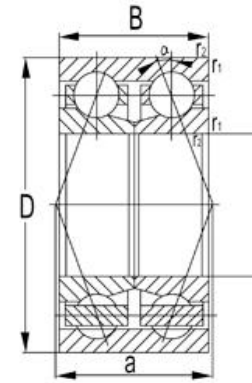

Bearing No.	Boundary dimensions				Basic load ratings(kN)		Limiting speed		Mass kg
	mm				Dynamic	Static	rpm		
	d	D	B	r _{smin}	Cr	Cor	Grease	Oil	
3302	15	42	19	1	14.2	11.8	9900	13000	0.127
3303	17	47	22.2	1	17.5	15	9000	12000	0.185
3304	20	52	22.2	1.1	21.1	18.6	8000	11000	0.221
3305	25	62	25.4	1.1	29.4	26.8	6700	8900	0.354
3306	30	72	30.2	1.1	39	36.5	5700	7600	0.558
3307	35	80	34.9	1.5	49.5	47.5	5000	6600	0.756
3308	40	90	36.5	1.5	54.5	57.5	4400	5900	1.03
3309	45	100	39.7	1.5	67.5	72.5	4000	5300	1.37
3310	50	110	44.4	2	81.5	89.5	3600	4800	1.98
3311	55	120	49.2	2	96.5	108	3300	4400	2.42
3312	60	130	54	2.1	113	128	3000	4000	3.07
3313	65	140	58.7	2.1	131	150	2800	3700	3.9
3314	70	150	63.5	2.1	153	168	2600	3500	5.2
3315	75	160	68.3	2.1	172	191	2400	3200	6.3

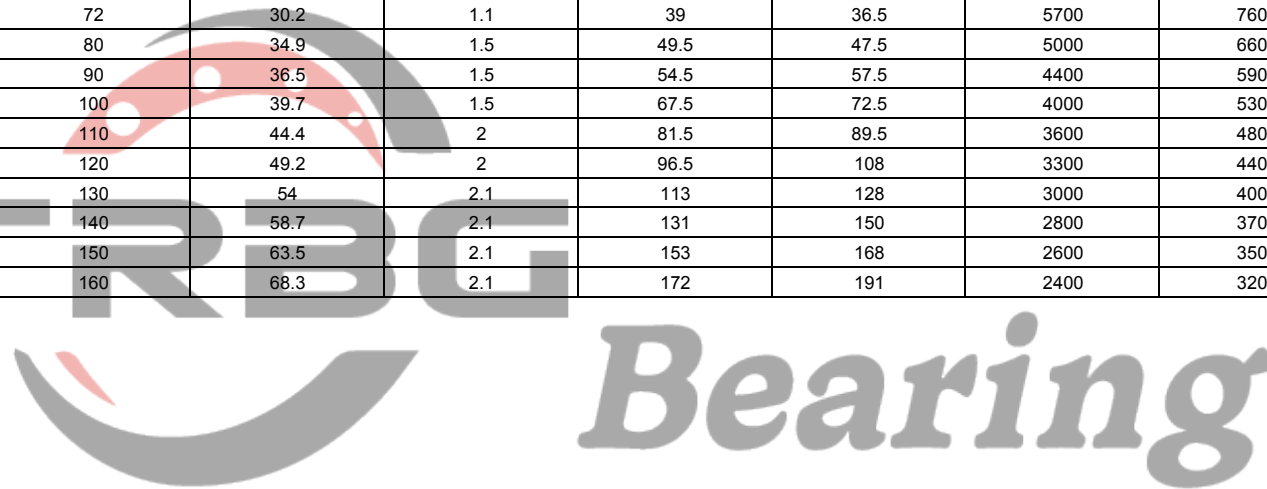

ANGULAR CONTACT BALL BEARING

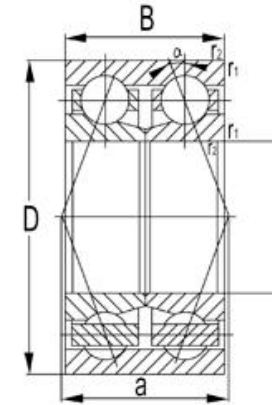

Bearing No.	Boundary dimensions				Basic load ratings(kN)		Limiting speed		Mass kg
	mm				Dynamic	Static	rpm		
	d	D	B	r _{smin}	Cr	Cor	Grease	Oil	
4200	10	30	14	0.6	7.7	5.9	18000	22000	0.057
4201	12	32	14	0.6	7.75	6.15	17000	20000	0.062
4202	15	35	14	0.6	9.75	9	14000	17000	0.071
4203	17	40	16	0.6	11.7	10.4	12000	15000	0.106
4204	20	47	18	1	16.4	12.5	10000	13000	0.165
4205	25	52	18	1	19	14.6	9000	11000	0.189
4206	30	62	20	1	26	20.8	8000	9500	0.298
4207	35	72	23	1.1	35.1	28.5	6700	8000	0.46
4208	40	80	23	1.1	37.1	32.5	6000	7000	0.558
4209	45	85	23	1.1	39	36	5600	6700	0.605
4210	50	90	23	1.1	41	40	5000	6000	0.651
4211	55	100	25	1.5	44.9	44	4800	5600	0.882
4212	60	110	28	1.5	57.2	55	4500	5300	1.2
4213	65	120	31	1.5	67.6	67	4000	4800	1.45
4214	70	125	31	1.5	70.2	73.5	3600	4300	1.5
4215	75	130	31	1.5	72.8	80	3400	4000	1.6
4216	80	140	33	2	80.6	90	3200	3800	2
4217	85	150	36	2	93.6	102	3000	3600	2.55
4218	90	160	40	2	112	122	2800	3400	3.2

ANGULAR CONTACT BALL BEARING

4220	100	180	46	2.1	14	15.6	2400	3000	4.7
------	-----	-----	----	-----	----	------	------	------	-----



ANGULAR CONTACT BALL BEARING

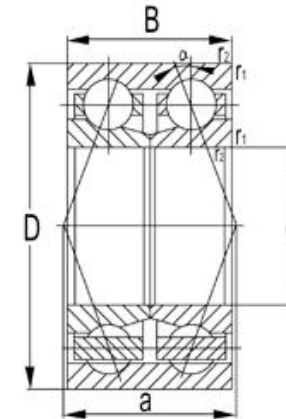

Bearing No.	Boundary dimensions				Basic load ratings(kN)		Limiting speed		Mass kg
	mm				Dynamic	Static	rpm		
	d	D	B	r _{smin}	Cr	Cor	Grease	Oil	
4300	10	35	17	0.6	14.3	8.9	18600	17500	0.091
4301	12	37	17	1	13	7.8	15000	16500	0.092
4302	15	42	17	1	13.1	11.7	12000	15000	0.123
4303	17	47	19	1	16.5	15	10000	13000	0.171
4304	20	52	21	1.1	19.5	17	9500	12000	0.227
4305	25	62	24	1.1	26.3	25.7	8500	10000	0.365
4306	30	72	27	1.1	35.5	35.9	7000	8500	0.542
4307	35	80	31	1.5	40.6	41.8	6300	7500	0.752
4308	40	90	33	1.5	46	48.8	5600	6700	0.958
4309	45	100	36	1.5	57.6	62.4	5000	6000	1.35
4310	50	110	40	2	81.9	69.5	4500	5300	1.7
4311	55	120	43	2	97.5	83	4300	5000	2.15
4312	60	130	46	2.1	112	98	3800	4500	2.65
4313	65	140	48	2.1	121	106	3600	4300	3.25
4314	70	150	51	2.1	138	125	3200	3800	3.95
4315	75	160	55	2.1	156	143	3000	3600	4.8

ANGULAR CONTACT BALL BEARING

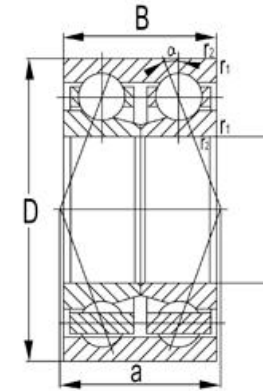

Bearing No.	Boundary dimensions				Basic load ratings(kN)		Limiting speed		Mass kg
	mm				Dynamic	Static	rpm		
	d	D	B	r_{smin}	Cr	Cor	Grease	Oil	
5200	10	30	14.3	0.6	6.95	3.8	14000	19000	0.049
5201	12	32	15.9	0.6	9.15	5.05	13000	17000	0.057
5202	15	35	15.9	0.6	10	6.05	11000	15000	0.064
5203	17	40	17.5	0.6	12.8	7.9	9900	13000	0.096
5204	20	47	20.6	1	19	12.1	8800	12000	0.153
5205	25	52	20.6	1	20.6	14.3	7300	9800	0.175
5206	30	62	23.8	1	28.5	20.4	6300	8400	0.286
5207	35	72	27	1.1	38	27.8	5500	7400	0.436
5208	40	80	30.2	1.1	42.5	32.5	4900	6600	0.59
5209	45	85	30.2	1.1	48	37	4400	5900	0.64
5210	50	90	30.2	1.5	51	42	4000	5300	0.689
5211	55	100	33.3	1.5	63	53	3600	4900	0.986
5212	60	110	36.5	1.5	71.5	58.5	3400	4500	1.27
5213	65	120	38.1	1.5	83.5	72.5	3100	4200	1.57
5214	70	125	39.7	1.5	90.5	79.5	2900	3900	1.8
5215	75	130	41.3	1.5	90	80.5	2700	3600	1.9
5216	80	140	44.4	2	106	95.5	2500	3400	2.39
5217	85	150	49.2	2	112	106	2400	3200	3.06
5218	90	160	52.4	2	140	129	2200	3000	3.73

ANGULAR CONTACT BALL BEARING

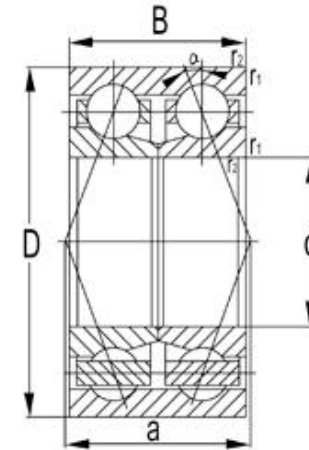

Bearing No.	Boundary dimensions				Basic load ratings(kN)		Limiting speed		Mass
	mm				Dynamic	Static	rpm		kg
	d	D	B	r _{smin}	Cr	Cor	Grease	Oil	
5302	15	42	19	1	17.2	10.1	9900	13000	0.132
5303	17	47	22.2	1	20.4	12.1	9000	12000	0.181
5304	20	52	22.2	1.1	20.6	12.7	8000	11000	0.217
5305	25	62	25.4	1.1	30.5	20.5	6700	8900	0.362
5306	30	72	30.2	1.1	39.5	27.5	5700	7600	0.553
5307	35	80	34.9	1.5	49.5	35	5000	6600	0.766
5308	40	90	36.5	1.5	60.5	44	4400	5900	1.01
5309	45	100	39.7	1.5	72.5	54	4000	5300	1.34
5310	50	110	44.4	2	85.5	64.5	3600	4800	1.81
5311	55	120	49.2	2	106	82	3300	4400	2.32
5312	60	130	54	2.1	122	95.5	3000	4000	3.05
5313	65	140	58.7	2.1	138	109	2800	3700	3.96
5314	70	150	63.5	2.1	155	125	2600	3500	4.74
5315	75	160	68.3	2.1	168	141	2400	3200	5.65

ANGULAR CONTACT BALL BEARING

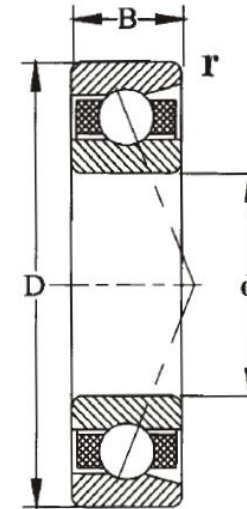

Bearing No.	Boundary dimensions			Basic load ratings(kN)		Limiting speed		Mass
	mm			Dynamic	Static	rpm		
	d	D	B	Cr	Cor	Grease	Oil	kg
7000AC	10	26	8	4.7	2.1	24,000	32,000	0.019
7001AC	12	28	8	5.1	2.4	22,000	28,000	0.021
7002AC	15	32	9	5.9	3.2	19,000	25,000	0.03
7003AC	17	35	10	6.3	3.6	16,000	22,000	0.04
7004AC	20	42	12	10	5.7	14,000	19,000	0.064
7005AC	25	47	12	11.1	7	12,000	17,000	0.074
7006AC	30	55	13	14.4	9.8	9,500	14,000	0.11
7007AC	35	62	14	17.3	12.1	8,500	12,000	0.15
7008AC	40	68	15	18.7	14.1	8,000	11,000	0.18
7009AC	45	75	16	24.7	19.1	7,500	10,000	0.23
7010AC	50	80	16	25.3	20.5	6,700	9,000	0.25
7011AC	55	90	18	35.5	26.5	6,000	8,000	0.38
7012AC	60	95	18	37	31.3	5,600	7,500	0.4

ANGULAR CONTACT BALL BEARING

7013AC	65	100	18	38	33.6	5,300	7,000	0.43
7014AC	70	110	20	45.8	40.9	5,000	6,700	0.6
7015AC	75	115	20	47.5	43.3	4,800	6,300	0.63
7016AC	80	125	22	57.5	51	4,500	6,000	0.85
7017AC	85	130	22	55	52.8	4,300	5,600	0.89
7018AC	90	140	24	71.7	68.7	4,000	5,300	1.15
7019AC	95	145	24	69.8	69.1	3,800	5,000	1.2
7020AC	100	150	24	69	69.7	3,800	5,000	1.25
7021AC	105	160	26	80.9	72.2	3,600	4,800	1.6
7022AC	110	170	28	98.5	93.9	3,400	4,600	1.95
7024AC	120	180	28	103.5	104.5	2,800	3,800	2.1
7026AC	130	200	33	122.4	127.8	2,600	3,400	3.33
7028AC	140	210	33	145.3	152.8	2,400	3,200	3.46
7030AC	150	225	35	174.2	184.9	2,200	3,000	4.8
7032AC	160	240	38	189.6	209	2,000	2,800	5.26



ANGULAR CONTACT BALL BEARING

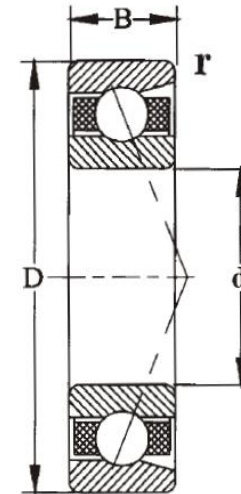

Bearing No.	Boundary dimensions			Basic load ratings(kN)		Limiting speed		Mass kg
	mm			Dynamic	Static	rpm		
	d	D	B	Cr	Cor	Grease	Oil	
7000C	10	26	8	4.9	2.1	24,000	32,000	0.019
7001C	12	28	8	5.4	2.6	22,000	28,000	0.021
7002C	15	32	9	6.2	3.3	19,000	25,000	0.03
7003C	17	35	10	6.6	3.6	16,000	22,000	0.04
7004C	20	42	12	10.4	6	14,000	19,000	0.064
7005C	25	47	12	11.6	7.4	12,000	17,000	0.074
7006C	30	55	13	15.1	10.2	9,500	14,000	0.11
7007C	35	62	14	18.2	12.7	8,500	12,000	0.15
7008C	40	68	15	19.7	14.9	8,000	11,000	0.18
7009C	45	75	16	25.9	20.2	7,500	10,000	0.23
7010C	50	80	16	26.6	21.8	6,700	9,000	0.25
7011C	55	90	18	38.9	29.5	6,000	8,000	0.38
7012C	60	95	18	40.9	33.1	5,600	7,500	0.4
7013C	65	100	18	40.1	35.3	5,300	7,000	0.43

ANGULAR CONTACT BALL BEARING

7014C	70	110	20	48.3	43.1	5,000	6,700	0.6
7015C	75	115	20	49.6	45.9	4,800	6,300	0.63
7016C	80	125	22	58.9	54.7	4,500	6,000	0.85
7017C	85	130	22	58.1	55.9	4,300	5,600	0.89
7018C	90	140	24	71.7	68.7	4,000	5,300	1.15
7019C	95	145	24	73.5	73.1	3,800	5,000	1.2
7020C	100	150	24	74.4	72.5	3,800	5,000	1.25
7021C	105	160	26	80.6	81.1	3,600	4,800	1.6
7022C	110	170	28	101.4	100.3	3,400	4,600	1.95
7024C	120	180	28	108.6	110.7	2,800	3,800	2.1
7026C	130	200	33	129.4	134.7	2,600	3,400	3.33
7028C	140	210	33	153.4	160.5	2,400	3,200	3.46
7030C	150	225	35	183.9	194.2	2,200	3,000	4.8
7032C	160	240	38	200.1	219.4	2,000	2,800	5.26



ANGULAR CONTACT BALL BEARING

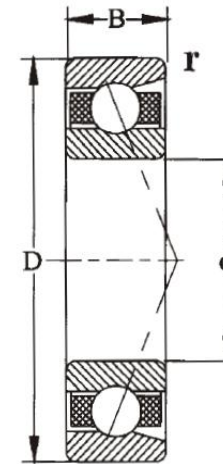

Bearing No.	Boundary dimensions			Basic load ratings(kN)		Limiting speed		Mass kg
	mm			Dynamic	Static	rpm		
	d	D	B	Cr	Cor	Grease	Oil	
7200AC	10	30	9	5.5	2.8	22,000	28,000	0.032
7201AC	12	32	10	7.6	3.6	20,000	25,000	0.037
7202AC	15	35	11	8.9	4.8	17,000	22,000	0.045
7203AC	17	40	12	10.4	5.6	15,000	20,000	0.062
7204AC	20	47	14	14	7.8	13,000	18,000	0.1
7205AC	25	52	15	15.8	9.7	11,000	16,000	0.12
7206AC	30	62	16	22.1	13.5	9,000	13,000	0.19
7207AC	35	72	17	29.2	18	8,000	11,000	0.28
7208AC	40	80	18	36.8	25.4	7,500	10,000	0.37
7209AC	45	85	19	38.6	28.1	6,700	9,000	0.41
7210AC	50	90	20	40.8	30.1	6,300	8,500	0.46
7211AC	55	100	21	50.8	38.2	5,600	7,000	0.61
7212AC	60	110	22	58.1	46	5,300	7,000	0.8
7213AC	65	120	23	66.6	52.1	4,800	6,300	1
7214AC	70	125	24	69.4	57	4,500	5,800	1.1
7215AC	75	130	25	75.3	62.8	4,300	5,600	1.2

ANGULAR CONTACT BALL BEARING

7216AC	80	140	26	91.3	65.1	4,000	5,300	1.45
7217AC	85	150	28	94.9	80.8	3,800	5,000	1.8
7218AC	90	160	30	122	106.5	3,600	4,800	2.25
7219AC	95	170	32	128.4	107.8	3,400	4,500	2.7
7220AC	100	180	34	142.3	120.6	3,200	4,300	3.25
7221AC	105	190	36	159	135.1	3,000	4,000	3.85
7222AC	110	200	38	176.3	151.2	2,800	3,800	4.55
7224AC	120	215	40	193.6	170.9	2,400	3,400	5.4
7226AC	130	230	40	196.4	200.1	2,000	3,000	6.45



ANGULAR CONTACT BALL BEARING

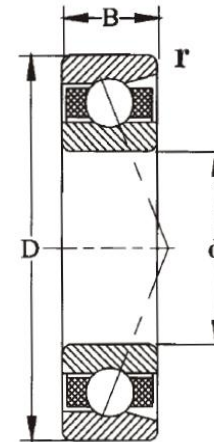

Bearing No.	Boundary dimensions			Basic load ratings(kN)		Limiting speed		Mass kg
	mm			Dynamic	Static	rpm		
	d	D	B	Cr	Cor	Grease	Oil	
7200B	10	30	9	5.3	2.7	19,000	27,000	0.03
7201B	12	32	10	6.9	3.2	18,000	24,000	0.036
7202B	15	35	11	7.9	4.2	16,000	22,000	0.045
7203B	17	40	12	9.9	5.5	14,000	19,000	0.065
7204B	20	47	14	13.4	7.6	12,000	16,000	0.11
7205B	25	52	15	14.8	9.3	10,000	14,000	0.13
7206B	30	62	16	20.5	13.5	8,500	12,000	0.2
7207B	35	72	17	28.3	14.8	7,500	10,000	0.28
7208B	40	80	18	34.5	23.8	6,700	9,000	0.42
7209B	45	85	19	34	24.6	6,300	8,500	0.42
7210B	50	90	20	40.4	25.6	5,600	8,000	0.47
7211B	55	100	21	46.3	36	5,300	7,000	0.62
7212B	60	110	22	56.1	44.3	4,800	6,300	0.8
7213B	65	120	23	65.7	50.2	4,300	6,000	1
7214B	70	125	24	70.4	56.3	4,000	5,600	1.1
7215B	75	130	25	68.6	58.2	3,800	5,300	1.2
7216B	80	140	26	78.7	65.7	4,000	5,300	1.45
7217B	85	150	28	83.2	74.1	3,600	5,000	1.85

ANGULAR CONTACT BALL BEARING

7218B	90	160	30	107.6	92.4	3,200	4,300	2.3
7219B	95	170	32	121.4	106.7	3,000	4,000	2.7
7220B	100	180	34	140.7	102.5	2,800	3,800	3.3
7221B	105	190	36	143.3	128.5	2,800	3,800	3.55
7222B	110	200	38	153.8	144.3	2,400	3,400	4.35
7224B	120	215	40	165.4	161.4	2,200	3,200	5.2
7226B	130	230	40	170.8	174.2	1,800	2,800	6.05



ANGULAR CONTACT BALL BEARING

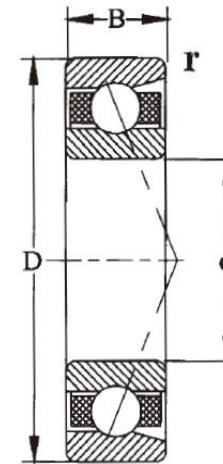

Bearing No.	Boundary dimensions			Basic load ratings(kN)		Limiting speed		Mass kg
	mm			Dynamic	Static	rpm		
	d	D	B	Cr	Cor	Grease	Oil	
7200C	10	30	9	5.5	2.8	22,000	28,000	0.032
7201C	12	32	10	7.9	3.8	20,000	25,000	0.037
7202C	15	35	11	9.2	4.9	17,000	22,000	0.045
7203C	17	40	12	10.8	5.8	15,000	20,000	0.062
7204C	20	47	14	14.5	8.1	13,000	18,000	0.1
7205C	25	52	15	16.5	10	11,000	16,000	0.12
7206C	30	62	16	23	14.7	9,000	13,000	0.19
7207C	35	72	17	30.3	20	8,000	11,000	0.28
7208C	40	80	18	38.4	26.3	7,500	10,000	0.37
7209C	45	85	19	40.4	29.3	6,700	9,000	0.41
7210C	50	90	20	42.8	31.3	6,300	8,500	0.46
7211C	55	100	21	53.2	39.9	5,600	7,000	0.61
7212C	60	110	22	61	48.2	5,300	7,000	0.8
7213C	65	120	23	69.8	54.4	4,800	6,300	1
7214C	70	125	24	72.8	59.7	4,500	5,800	1.1
7215C	75	130	25	79.2	65.6	4,300	5,600	1.2

ANGULAR CONTACT BALL BEARING

7216C	80	140	26	92.5	66.2	4,000	5,300	1.45
7217C	85	150	28	99.7	84.6	3,800	5,000	1.8
7218C	90	160	30	128	111.7	3,600	4,800	2.25
7219C	95	170	32	134.6	112.2	3,400	4,500	2.7
7220C	100	180	34	149.1	125.4	3,200	4,300	3.25
7221C	105	190	36	166.6	138.6	3,000	4,000	3.85
7222C	110	200	38	184.7	154.8	2,800	3,800	4.55
7224C	120	215	40	203.1	178.4	2,400	3,400	5.4
7226C	130	230	40	206.6	209.2	2,000	3,000	6.45



ANGULAR CONTACT BALL BEARING

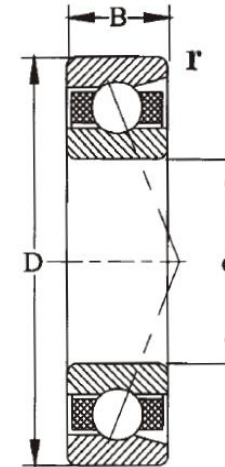

Bearing No.	Boundary dimensions			Basic load ratings(kN)		Limiting speed		Mass
	mm			Dynamic	Static	rpm		
	d	D	B	Cr	Cor	Grease	Oil	
7300AC	10	35	11	9.5	4.4	18,000	26,000	0.053
7301AC	12	37	12	11.5	5.4	17,000	24,000	0.06
7302AC	15	42	13	12.5	6.2	15,000	21,000	0.084
7303AC	17	47	14	15	7.7	13,000	19,000	0.16
7304AC	20	52	15	17.9	9.6	12,000	17,000	0.15
7305AC	25	62	17	27	15.6	9,500	14,000	0.23
7306AC	30	72	19	32.8	20.4	8,500	12,000	0.35
7307AC	35	80	21	38.2	24.9	7,500	10,000	0.47
7308AC	40	90	23	47	31.1	6,700	9,000	0.66
7309AC	45	100	25	61.6	41.2	6,000	8,000	0.86
7310AC	50	110	27	71.9	48.5	5,600	7,500	1.08
7311AC	55	120	29	83.4	58	5,000	6,700	1.42
7312AC	60	130	31	95.2	67.2	4,800	6,300	1.71
7313AC	65	140	33	38	33.6	4,300	5,600	2.23
7314AC	70	150	35	118.8	88.2	4,000	5,300	2.67
7315AC	75	160	37	134.4	99.8	3,800	5,000	3.1

ANGULAR CONTACT BALL BEARING

7316AC	80	170	39	149.5	107.7	3,600	4,800	3.6
7317AC	85	180	41	154.3	122.3	3,400	4,500	4.38
7318AC	90	190	43	177.6	153.5	3,200	4,300	5.6
7319AC	95	200	45	193.3	172.6	3,200	4,200	6.6
7320AC	100	215	47	213.5	198.6	3,000	4,000	7.58
7321AC	105	225	49	226.7	216.6	2,800	3,800	8.85
7322AC	110	240	50	253.2	252.4	2,600	3,600	10.5



ANGULAR CONTACT BALL BEARING

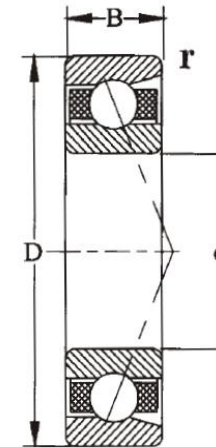

Bearing No.	Boundary dimensions			Basic load ratings(kN)		Limiting speed		Mass kg
	mm			Dynamic	Static	rpm		
	d	D	B	Cr	Cor	Grease	Oil	
7301B	12	37	12	10.5	4.9	16,000	22,000	0.06
7302B	15	42	13	12.4	6.5	14,000	19,000	0.08
7303B	17	47	14	14.1	8.1	13,000	17,000	0.16
7304B	20	52	15	17.3	9.6	11,000	15,000	0.14
7305B	25	62	17	24.3	14.1	9,000	13,000	0.23
7306B	30	72	19	29.3	18.1	8,000	11,000	0.34
7307B	35	80	21	38.3	24.4	7,000	9,500	0.45
7308B	40	90	23	46.5	29.5	6,300	8,500	0.63
7309B	45	100	25	59.6	39.6	5,600	7,500	0.85
7310B	50	110	27	68.1	48	5,000	6,700	1.1
7311B	55	120	29	82.2	56.2	4,500	6,300	1.4
7312B	60	130	31	91.5	65.4	4,300	5,600	1.75
7313B	65	140	33	102.3	75.3	3,800	5,300	2.15
7314B	70	150	35	114.6	85.9	3,600	5,000	2.65
7315B	75	160	37	127.7	95.4	3,400	4,800	3.2
7316B	80	170	39	141.4	107.9	3,200	4,800	3.8
7317B	85	180	41	155.8	120.9	3,000	4,000	4.45
7318B	90	190	43	157.9	136.9	3,000	4,000	5.3

ANGULAR CONTACT BALL BEARING

7319B	95	200	45	172	154.1	2,800	4,000	6.4
7320B	100	215	47	190	177.3	2,600	3,800	7.29
7321B	105	225	49	201.7	193.3	2,400	3,600	8.55
7322B	110	240	50	225.8	225.3	2,200	3,400	9.84



ANGULAR CONTACT BALL BEARING

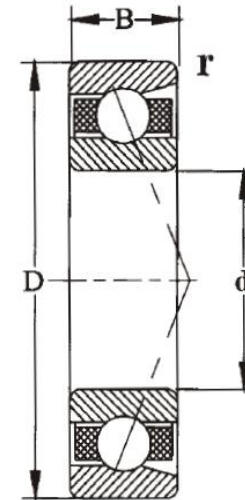

Bearing No.	Boundary dimensions			Basic load ratings(kN)		Limiting speed		Mass
	mm			Dynamic	Static	rpm		
	d	D	B	Cr	Cor	Grease	Oil	
7300C	10	35	11	9.8	4.6	18,000	26,000	0.053
7301C	12	37	12	11.8	5.6	17,000	24,000	0.06
7302C	15	42	13	13.2	6.7	15,000	21,000	0.084
7303C	17	47	14	15.7	8.2	13,000	19,000	0.16
7304C	20	52	15	18.4	9.8	12,000	17,000	0.15
7305C	25	62	17	27.8	15.9	9,500	14,000	0.23
7306C	30	72	19	33.2	21.2	8,500	12,000	0.35
7307C	35	80	21	40.3	25.8	7,500	10,000	0.47
7308C	40	90	23	49.3	32.3	6,700	9,000	0.66
7309C	45	100	25	63.1	42.9	6,000	8,000	0.86
7310C	50	110	27	74.9	50.9	5,600	7,500	1.08
7311C	55	120	29	86.4	59.5	5,000	6,700	1.42
7312C	60	130	31	98.6	68.5	4,800	6,300	1.71
7313C	65	140	33	113.1	79.6	4,300	5,600	2.23

ANGULAR CONTACT BALL BEARING

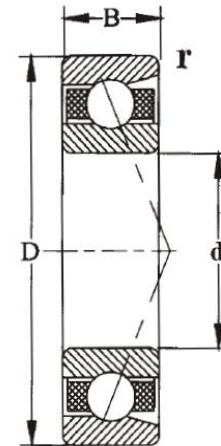

Bearing No.	Boundary dimensions			Basic load ratings(kN)		Limiting speed		Mass kg
	mm			Dynamic	Static	rpm		
	d	D	B	Cr	Cor	Grease	Oil	
7406AC	30	90	23	55.6	32.7	6,500	8,500	0.96
7407AC	35	100	25	66.4	41.9	5,500	8,000	1.14
7408AC	40	110	27	73.7	42.1	5,200	7,000	1.4
7409AC	45	120	29	84.5	55.1	5,000	6,500	1.8
7410AC	50	130	31	115.8	78.3	4,500	6,000	2.25
7411AC	55	140	33	121.4	84.5	4,200	5,600	2.75
7412AC	60	150	35	131.8	95.3	3,800	5,200	3.4
7413AC	65	160	37	142.5	106.7	3,400	4,800	4.2
7414AC	70	180	42	154.6	122	3,200	4,500	5.8
7415AC	75	190	45	165.2	133.5	3,000	4,200	7
7416AC	80	200	48	176.5	147.2	2,800	4,000	8.4
7417AC	85	210	52	188	161.5	2,600	3,700	9.6
7418AC	90	225	54	200.3	178.1	2,400	3,400	11.2

ANGULAR CONTACT BALL BEARING

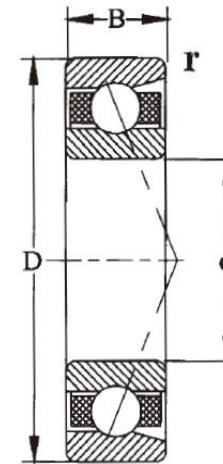

Bearing No.	Boundary dimensions			Basic load ratings(kN)		Limiting speed		Mass kg
	mm			Dynamic	Static	rpm		
	d	D	B	Cr	Cor	Grease	Oil	
7406B	30	90	23	51.4	30.1	6,000	8,000	0.9
7407B	35	100	25	60.2	37.9	5,000	7,500	1.1
7408B	40	110	27	70.1	49.1	5,000	6,500	1.35
7409B	45	120	29	80.7	44.1	4,500	6,000	1.75
7410B	50	130	31	105.3	71.2	4,000	5,500	2.1
7411B	55	140	33	110	76.3	3,800	5,200	2.55
7412B	60	150	35	119.3	86.1	3,500	4,700	3.2
7413B	65	160	37	128.7	96.4	3,200	4,500	4
7414B	70	180	42	138.7	109.6	3,000	4,200	5.55
7415B	75	190	45	148.4	120.4	2,800	4,000	6.8
7416B	80	200	48	158.4	132.4	2,600	3,700	8.18
7417B	85	210	52	168.6	145	2,400	3,400	9.3
7418B	90	225	54	179.1	159.2	2,300	3,200	10.8

ANGULAR CONTACT BALL BEARING

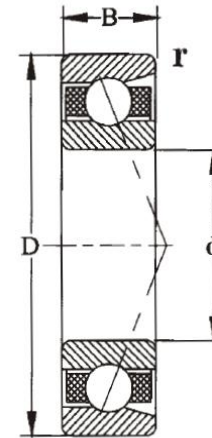

Bearing No.	Boundary dimensions			Basic load ratings(kN)		Limiting speed		Mass kg
	mm			Dynamic	Static	rpm		
	d	D	B	Cr	Cor	Grease	Oil	
7406C	30	90	23	57.5	33.8	6,500	8,500	0.96
7407C	35	100	25	66.8	41.2	5,500	8,000	1.14
7408C	40	110	27	80.2	53.3	5,200	7,000	1.4
7409C	45	120	29	93.1	60.8	5,000	6,500	1.8
7410C	50	130	31	119.3	81	4,500	6,000	2.25
7411C	55	140	33	125.3	87	4,200	5,600	2.75
7412C	60	150	35	136.3	98.2	3,800	5,200	3.4
7413C	65	160	37	147.4	110.2	3,400	4,800	4.2
7414C	70	180	42	160.4	126.6	3,200	4,500	5.8
7415C	75	190	45	171.4	138.9	3,000	4,200	7
7416C	80	200	48	183.2	152.9	2,800	4,000	8.4
7417C	85	210	52	195.1	167.6	2,600	3,700	9.6
7418C	90	225	54	208	184.2	2,400	3,400	11.2

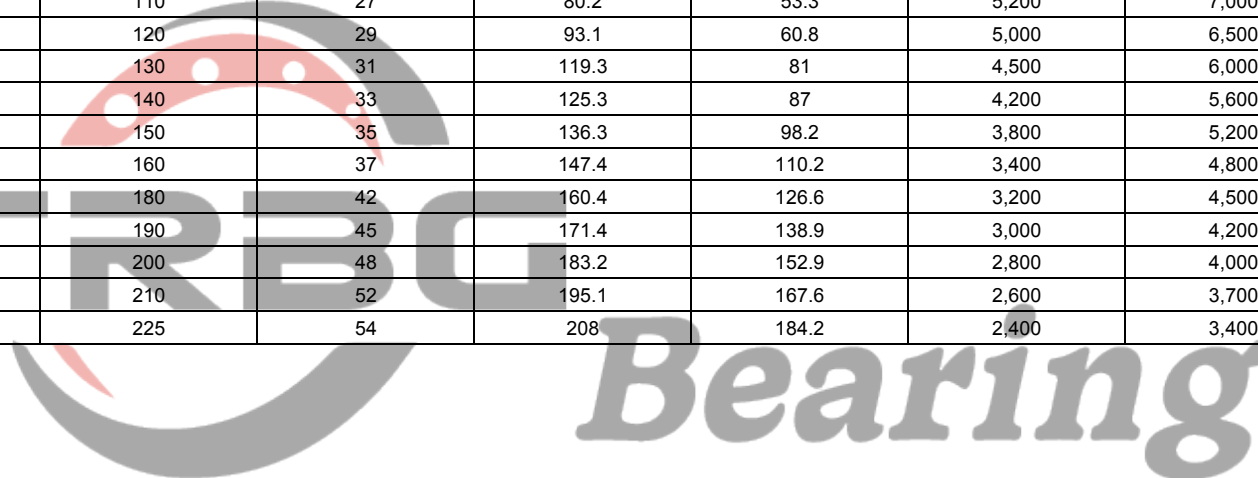

ANGULAR CONTACT BALL BEARING

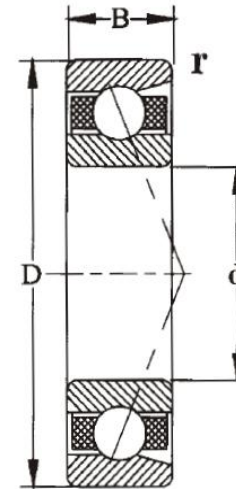

Bearing No.	Boundary dimensions			Basic load ratings(kN)		Limiting speed		Mass kg
	mm			Dynamic	Static	rpm		
	d	D	B	Cr	Cor	Grease	Oil	
7901AC	12	24	6	3.2	1.7	28,000	36,000	0.011
7902AC	15	28	7	4.5	2.5	24,000	32,000	0.015
7903AC	17	30	7	4.8	2.7	22,000	30,000	0.017
7904AC	20	37	9	6.4	4	20,000	28,000	0.035
7905AC	25	42	9	7.5	5.2	18,000	26,000	0.042
7906AC	30	47	9	7.9	6	16,000	24,000	0.048
7907AC	35	55	10	11.7	8.8	14,000	22,000	0.075
7908AC	40	62	12	14.1	10.1	12,000	20,000	0.11
7909AC	45	68	12	15.4	12.2	10,000	18,000	0.13
7910AC	50	72	12	16.1	14.8	8,000	16,000	0.14
7911AC	55	80	13	18.7	17.5	7,500	15,000	0.183
7912AC	60	85	13	19	18	7,000	14,000	0.198
7913AC	65	90	13	19.4	20	6,500	13,000	0.212
7914AC	70	100	16	27.1	26.3	6,300	12,000	0.342

ANGULAR CONTACT BALL BEARING

7915AC	75	105	16	27	27.7	6,000	10,000	0.36
7916AC	80	116	16	27.5	29	5,500	10,000	0.381
7917AC	85	120	18	38	39.1	5,000	9,000	0.542
7918AC	90	125	18	39.8	44.5	5,000	8,500	0.56
7919AC	95	130	18	40	45.5	4,500	8,500	0.604
7920AC	100	140	20	46.4	50	4,300	8,200	0.808
7921AC	105	145	20	47	55.2	4,000	8,000	0.83
7922AC	110	150	20	49.7	55.3	3,800	7,500	0.88
7924AC	120	165	22	68.4	77.6	3,600	7,200	1.15
7926AC	130	180	24	73.4	88.1	3,400	7,000	1.54
7928AC	140	190	24	74.5	90.2	3,200	6,800	1.64
7930AC	150	210	28	95.6	117.2	3,000	6,500	2.97
7932AC	160	220	28	135.4	158.6	2,800	6,300	3.12



ANGULAR CONTACT BALL BEARING

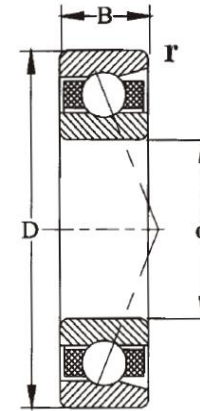

Bearing No.	Boundary dimensions			Basic load ratings(kN)		Limiting speed		Mass kg
	mm			Dynamic	Static	rpm		
	d	D	B	Cr	Cor	Grease	Oil	
7901C	12	24	6	3.3	1.8	28,000	36,000	0.011
7902C	15	28	7	4.7	2.6	24,000	32,000	0.015
7903C	17	30	7	5	2.8	22,000	30,000	0.017
7904C	20	37	9	6.8	4.2	20,000	28,000	0.035
7905C	25	42	9	7.8	5.4	18,000	26,000	0.042
7906C	30	47	9	8.2	6.2	16,000	24,000	0.048
7907C	35	55	10	12	9.1	14,000	22,000	0.075
7908C	40	62	12	14.5	10.6	12,000	20,000	0.11
7909C	45	68	12	16	12.6	10,000	18,000	0.13
7910C	50	72	12	16.5	15	8,000	16,000	0.14
7911C	55	80	13	19.1	17.8	7,500	15,000	0.183
7912C	60	85	13	19.5	18.5	7,000	14,000	0.198
7913C	65	90	13	20.3	20.5	6,500	13,000	0.212
7914C	70	100	16	28.1	27.5	6,300	12,000	0.342
7915C	75	105	16	28.6	29.2	6,000	10,000	0.36
7916C	80	116	16	29	30.5	5,500	10,000	0.381
7917C	85	120	18	39	40.5	5,000	9,000	0.542
7918C	90	125	18	41.2	46	5,000	8,500	0.56
7919C	95	130	18	42.5	48	4,500	8,500	0.604
7920C	100	140	20	48.5	52	4,300	8,200	0.808
7921C	105	145	20	51	57	4,000	8,000	0.83

ANGULAR CONTACT BALL BEARING

7922C	110	150	20	52	58	3,800	7,500	0.88
7924C	120	165	22	72	80.1	3,600	7,200	1.15
7926C	130	180	24	77.5	90.1	3,400	7,000	1.54
7928C	140	190	24	79.5	95.5	3,200	6,800	1.64
7930C	150	210	28	102	122	3,000	6,500	2.97
7932C	160	220	28	145.6	167.4	2,800	6,300	3.12

